

cadre étagère contour.3'x8'

3' x 8' contour shelf module

NOTICE DE MONTAGE - SET UP INSTRUCTIONS
CADRES / VISUEL - GRAPHICS / FRAME

1

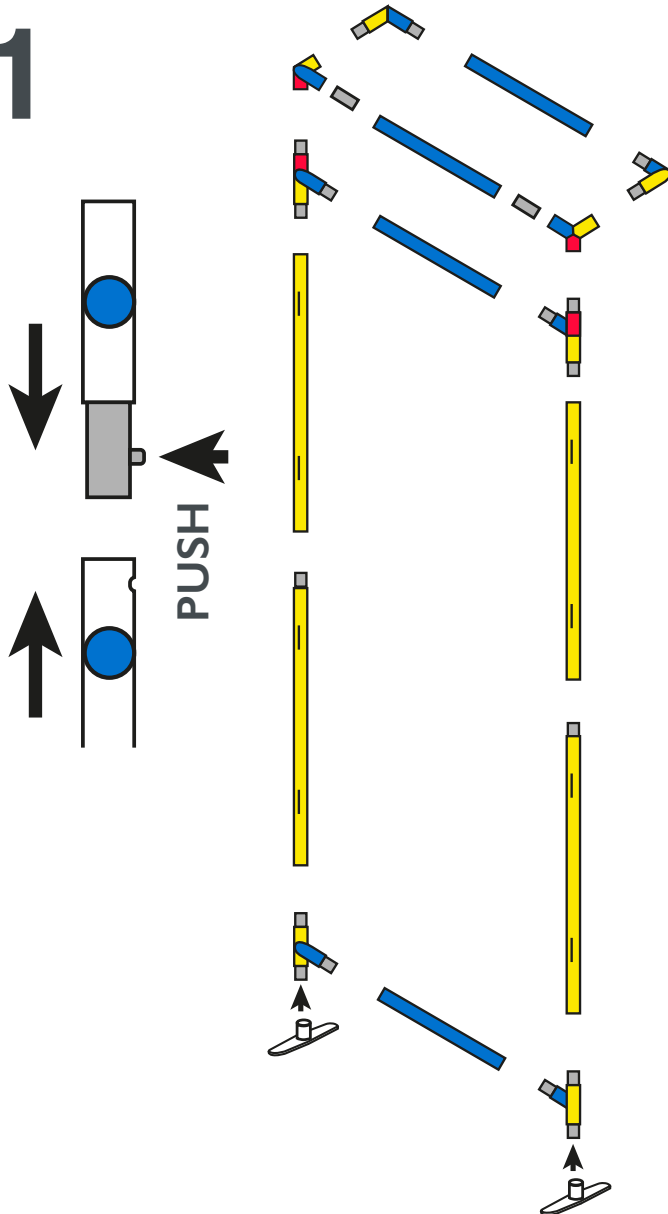

2

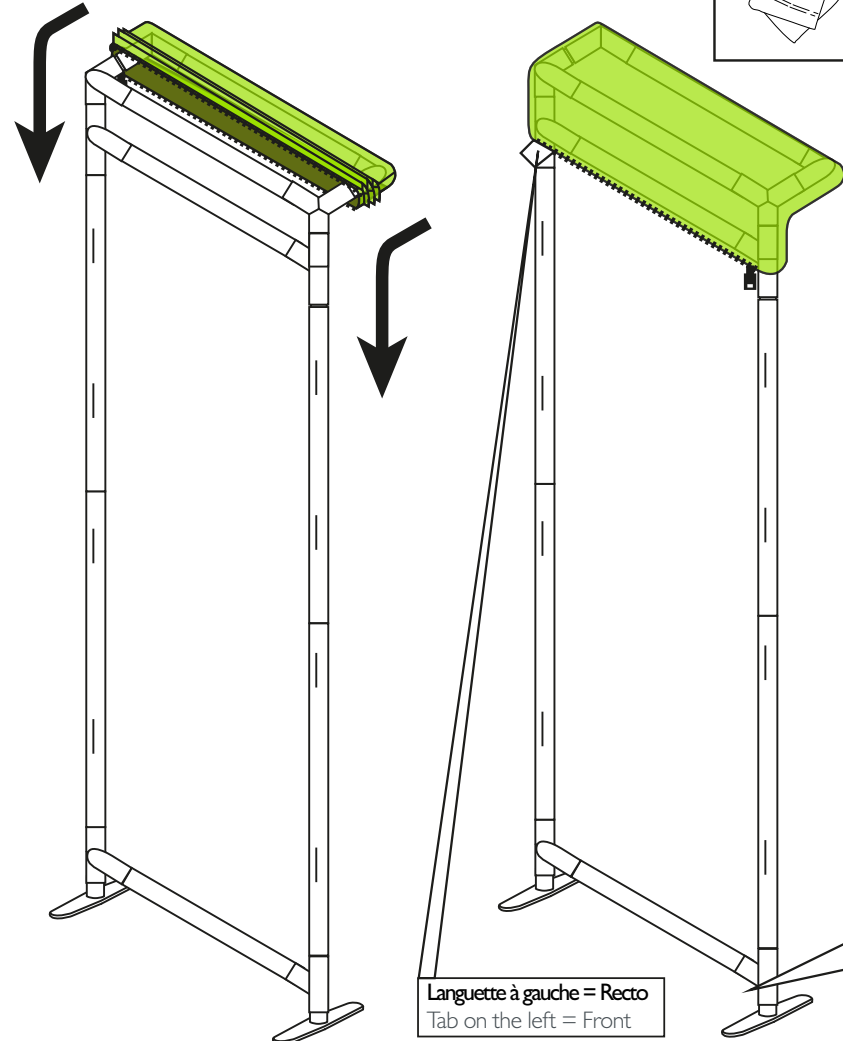

Languette à gauche = Recto
Tab on the left = Front

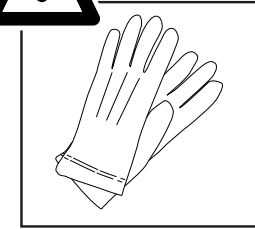

Conseils : utilisez les gants
et travaillez sur un
emplacement propre.
Tips: Use gloves and work
on a clean site.

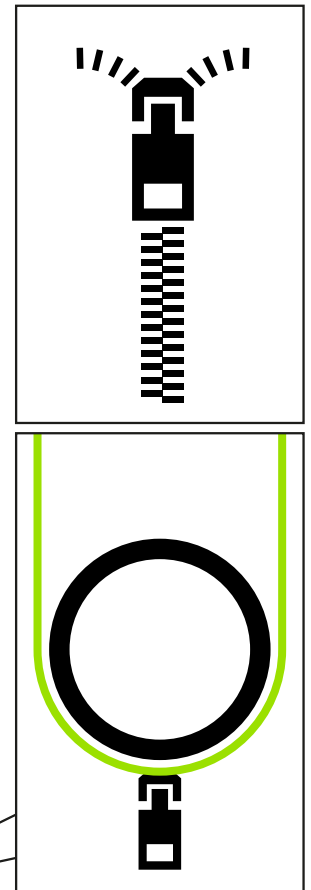

cadre étagère contour.3'x8'

3' x 8' contour shelf module

NOTICE DE MONTAGE - SET UP INSTRUCTIONS
ÉTAGÈRES / SHELVES

3

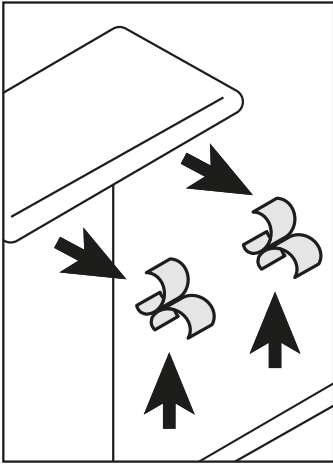

4

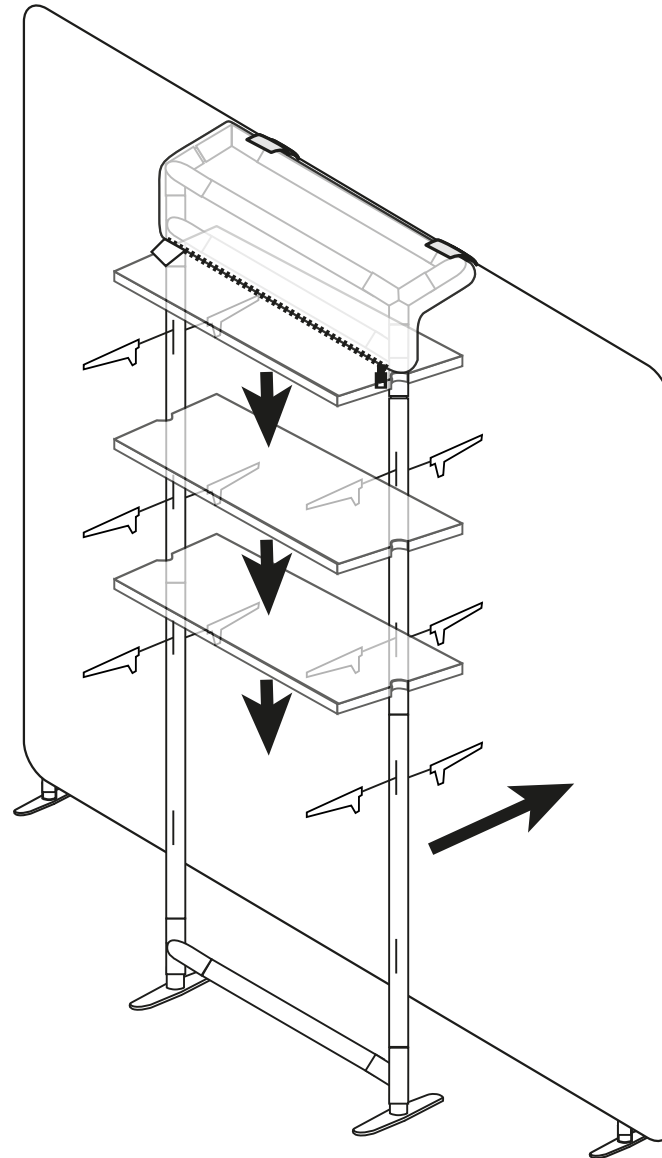
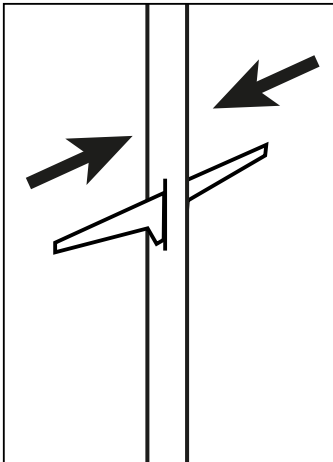

5

